

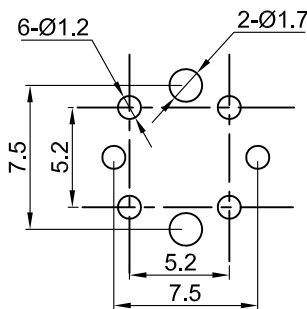

TS4

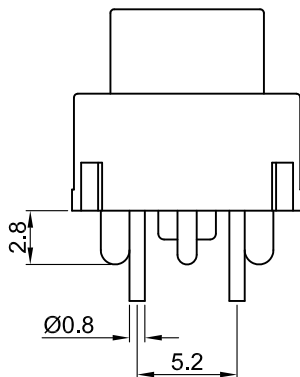

P.C.B.LAYOUT

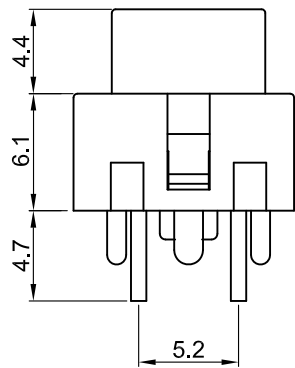
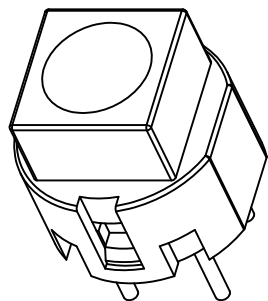
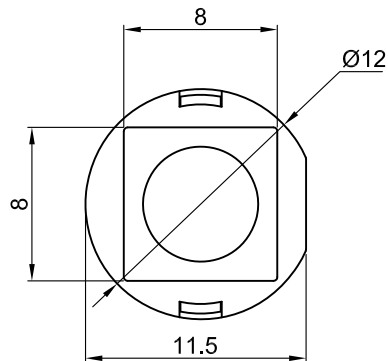
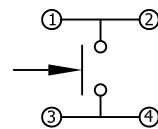

CIRCUIT

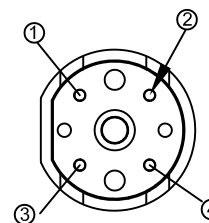

Specifications	
Circuit	:Push (NO)
Current rating	:30mA
Voltage rating	:30VDC
Dielectric withstanding voltage	:500VAC for 1 minute
Contact resistance	:100mΩ Max. (Inital)
Insulation resistance	:100MΩ Min
Operating force	:200±50gf
Total travel	:0.7mm±0.2mm
Operating life	:100,000 cycles Min.
Solder specifications	:256° C for 5 seconds
Operating temperature	:+10° C ~ +60° C
Function	:OFF - (ON)

MATERIAL:

Frame:Nylon66,UL rated:94V-2 Min. ;

Cap:ABS;

Terminal:Brass,Gold or Tin plated.

Y	Yellow	黄色
W	White	白色
U	Blue	蓝色
R	Red	红色
O	Orange	橙色
G	Green	绿色
B	Black	黑色
A	Gray	灰色
CAP COLOR (X)		

		公差 TOLEANCES		.X± 0.3	.XX± 0.15	角度	± 1°	单位 DIMENSION UNIT	mm.
		版本 VERSION	A0	比例尺 SCALE	NONE	日期 DATE	2020.07.21	品名 TITLE	图号 DRAWING NO
		核准 APPROVED BY	王龙	核对 CHECKED BY	Z. H. B.	绘图 DRAWN BY		TS4-1-R	TS4-1-R_A0
版本 VER.	变更说明 CHANGE DESCRIPTION	日期 DATE	ECN NO.	APPROVED BY	王龙	CHECKED BY	Z. H. B.	DRAWN BY	